

Vliet Zakstraat - Muntstraat

MECHELEN



Commissie openbare werken en groen
8 mei 2019

2003

Mechelen nam deel aan het Europese Interreg IIIB project “**Water in Historic City Centers**” samen met

- Breda (Ndl)
- Chester (Eng)
- Ghent (Bel)
- ‘s Hertogenbosch (Ndl)
- Limerick (Irl)



Water - vaak de **oorsprong** voor vele Europese steden

Water - **verwaarloosd** vanaf de 19e eeuw en **verdween** uit het straatbeeld

Nu wordt het belang van water terug (h)erkend;

Water = draagt bij aan de **ruimtelijke kwaliteit** en **aan herwaardering van stadskernen**

Water = draagt bij aan duurzaam **waterbeheer**

Water = brengt een **aangename sfeer**, samen met groene impulsen

Mechelen: water in de stad

De vlietjes - Bafferbrug en Zakbrug



De Vlietjes van Mechelen geschilderd door A. Ost 1912.
3de Reeks « Bafferbrug-Zakbrug »
2. De Bafferbrug gezien van in de vliet de Melan.

Mechelse Vlietjes

werden gedempt in het begin van de 20ste eeuw omdat dit:

- open riolen werden
- en er gezondheidsproblemen ontstonden

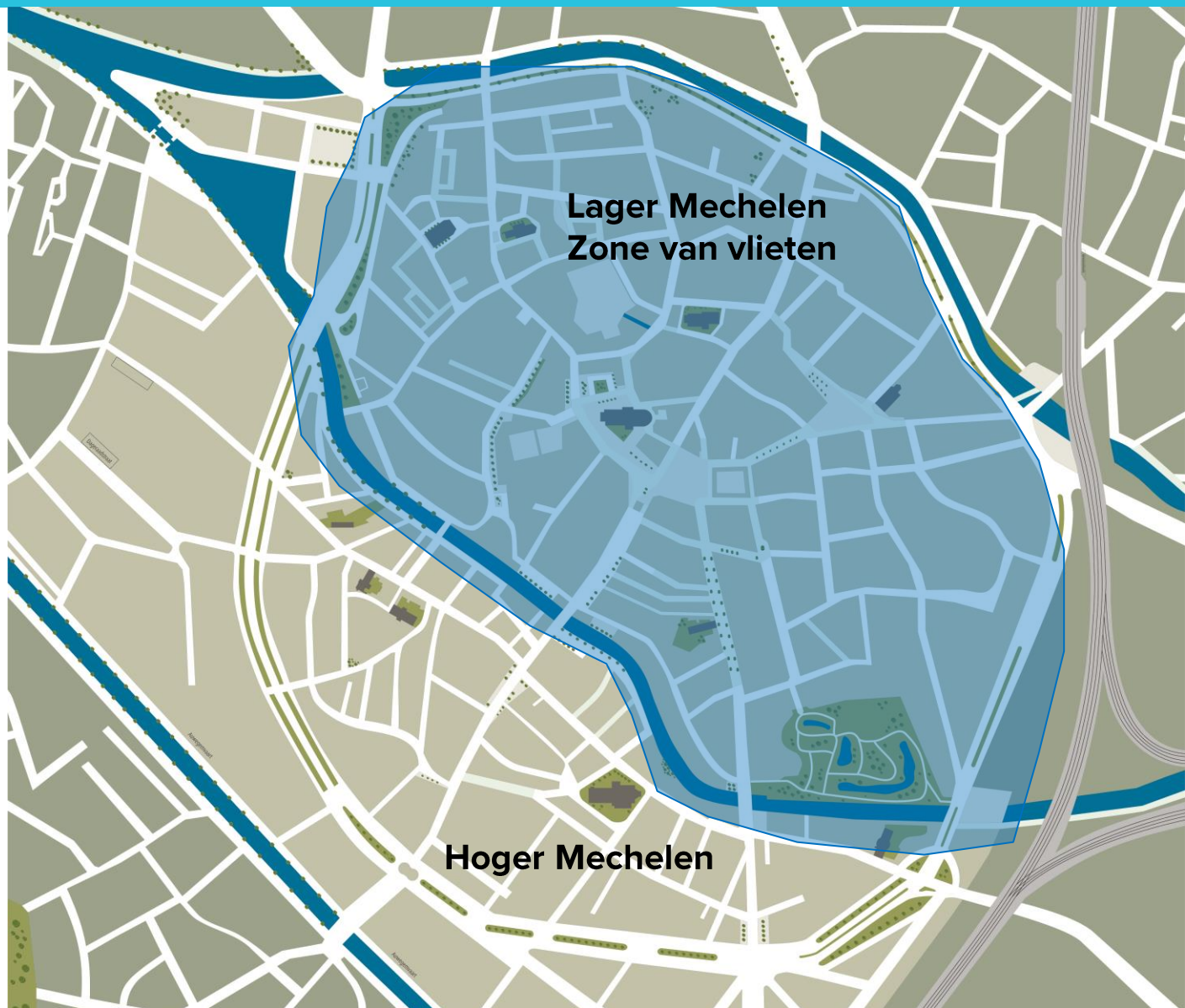

Mechelen: water in de stad



Melaan (2004)
parking



Mechelen: water in de stad



Mechelen: water in de stad

Het opnieuw openleggen van de Melaan is een **katalysator** geweest voor vele nieuwe projecten in de laatste jaren:

- Bij ieder nieuw project wordt het openen van vlieten overwogen
- In publieke projecten maar ook in **semi-publieke parken/projecten** en **private projecten**

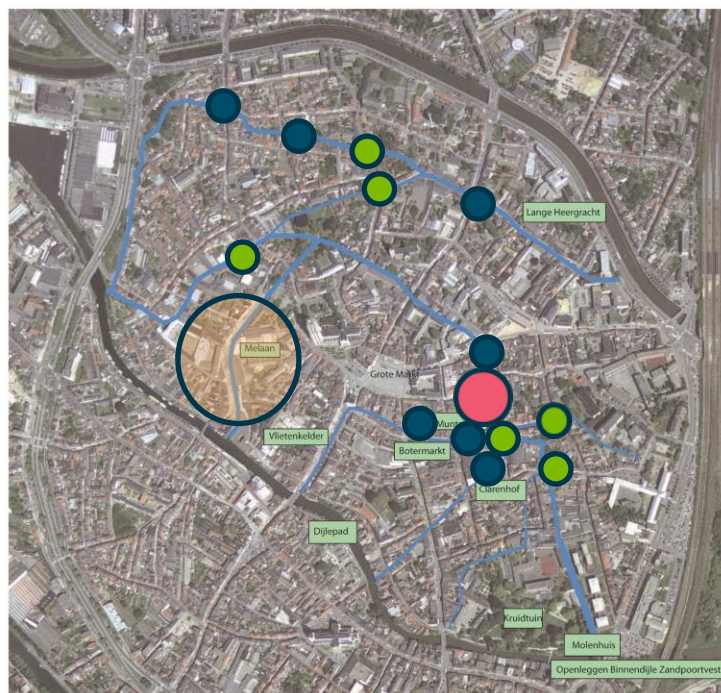

-  Zakstraat-Muntstraat
-  Melaan
-  Nieuw project – open water
-  Nieuw project – link naar water



Vliet Zakstraat - Muntstraat



2017 – deelname aan Europees Project Water Resilient Cities

Hoe steden weerbaar maken tegen gevolgen van klimaatverandering met betrekking tot water:

- **Wateroverlast**
- **Droogteresistentie**
- ...

Ruimte voor water

1. **Openleggen Binnendijle Zandpoortvest**
2. **Aanleg vliet Zakstraat – Muntstraat**
3. **Opwaardering kademuren Binnendijle**

Interreg 
EUROPEAN UNION

2 Seas Mers Zeeën

Water Resilient Cities

European Regional Development Fund

Vliet Zakstraat - Muntstraat

2018 – Opmaak ontwerp door OKRA Landschapsarchitecten



Definitief ontwerp

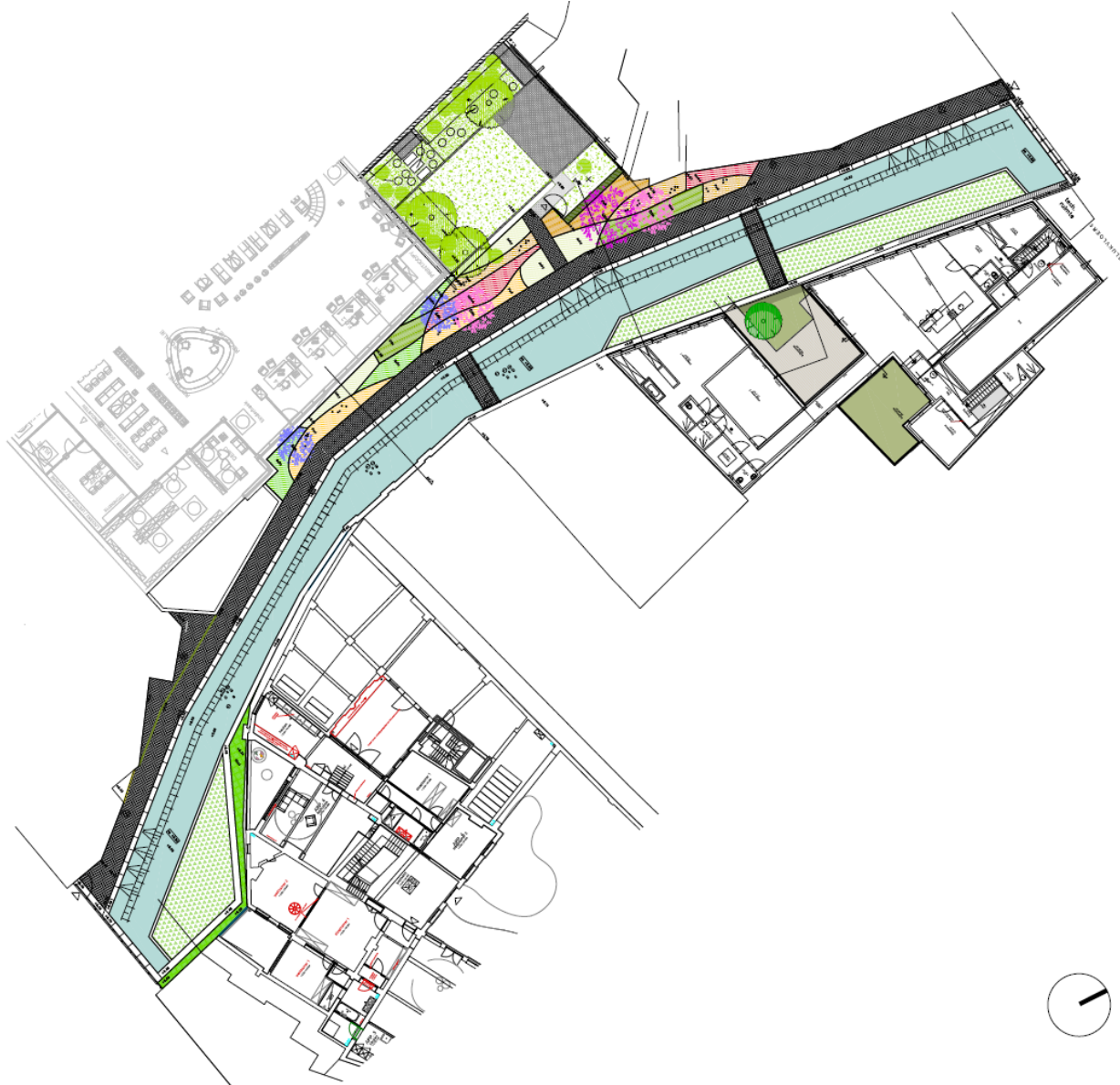

Definitief ontwerp



Definitief ontwerp

TOEGANGEN, ROUTE



lage reling naar analogie bruggen Melaan

Definitief ontwerp

BEPLANTING



Potentilla fruticosa
'Abbotswood'



Allium cristophii



Pennisetum villosum



Pennisetum alopecuroides
'Hameln'



Geranium 'Rozanne'



Viburnum davidii



Knautia macedonica



Anemone hybrida



Lonicera nitida 'Elegant'





Chaenomeles superba 'Jet Trail'

Definitief ontwerp

BOMEN



-  *Prunus subhirtella* 'Autumnalis Rosea' H: tot 5 m. vorm: meerstammig
-  *Cornus kousa* H tot 6-7 m
-  *Syringa vulgaris* 'Sensation' H: tot 4 m . vorm: meerstammig

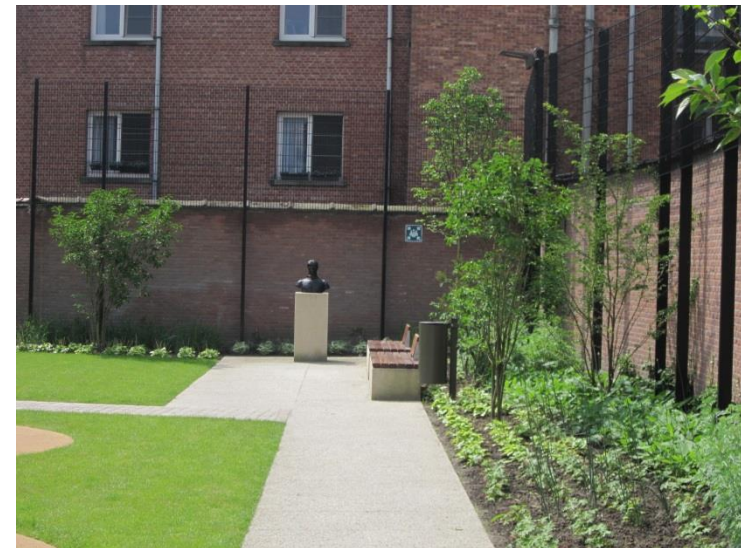

Definitief ontwerp

HELOFYTENFILTER



Helofytenfilter 1:

Iris pseudacorus
Acorus calamus
Sparganium erectum
Scirpus lacustris
Alisma plantago aquatica
Carex pseudocyperus
Ranunculus lingua 'Grandiflora'

Helofytenfilter 2:

Acorus calamus
Butomus umbellatus
Lytrum salicaria 'Robert'
Pontederia cordata
Lysimachia thyrsiflora
Caltha palustris



Definitief ontwerp

VERLICHTING



wandspot, strijklucht over op vliet



wandarmatuur

Definitief ontwerp

MATERIALIZATIE

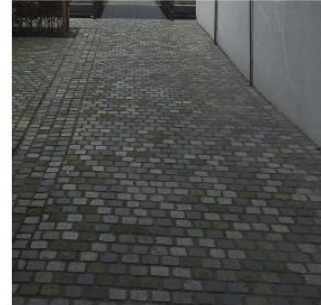
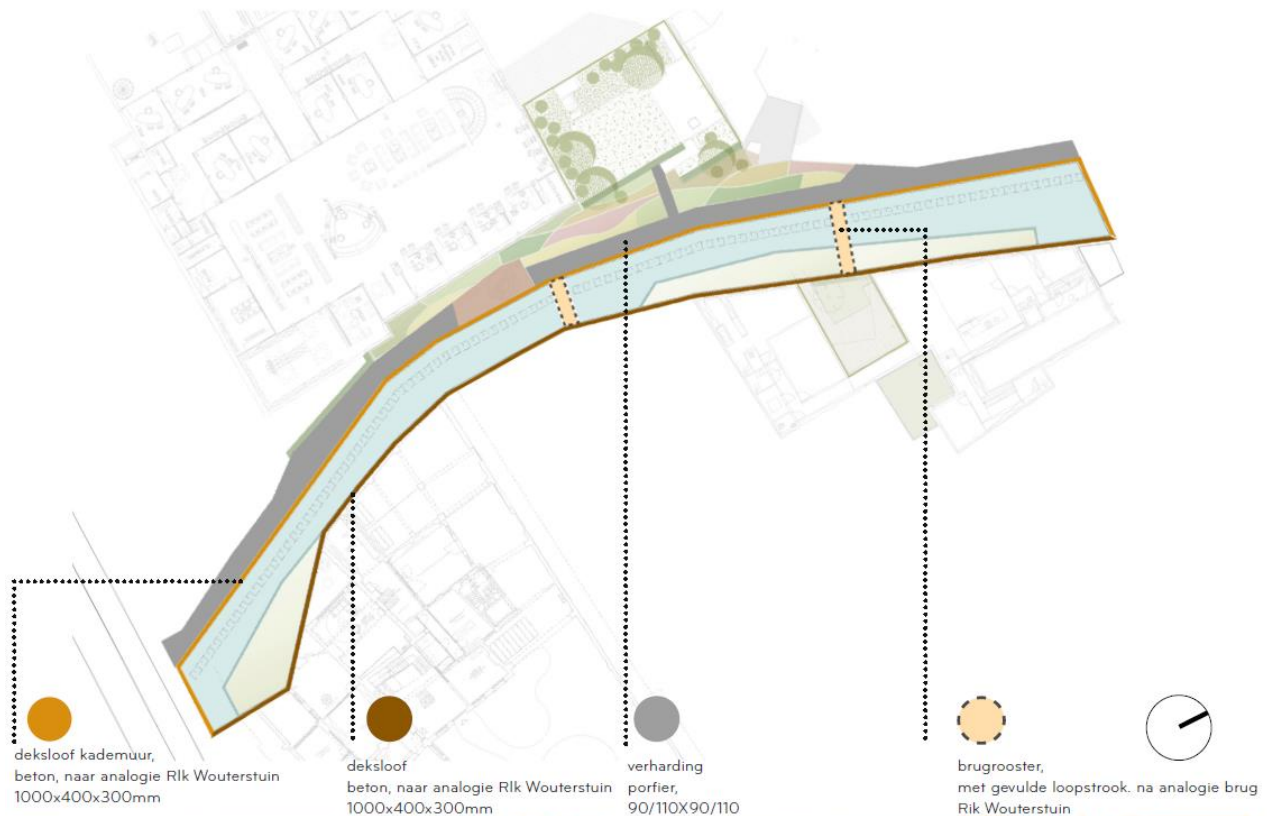

Definitief ontwerp

BRUGGEN EN POORTEN

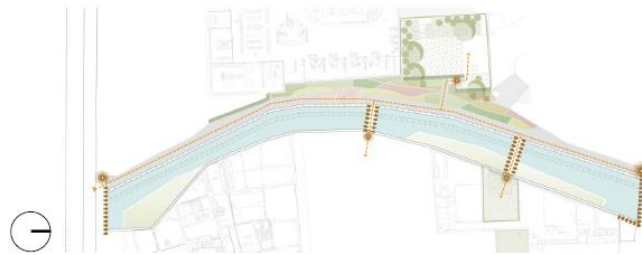
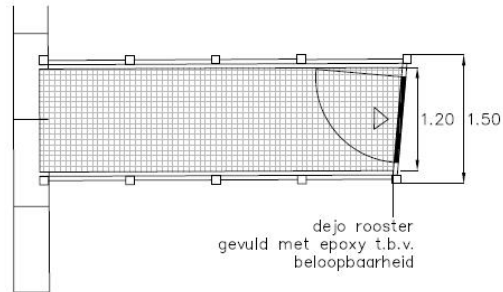
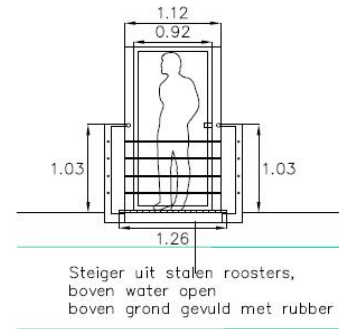
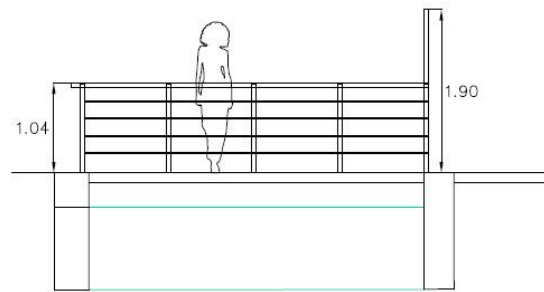

Definitief ontwerp



SNEDE A-A'

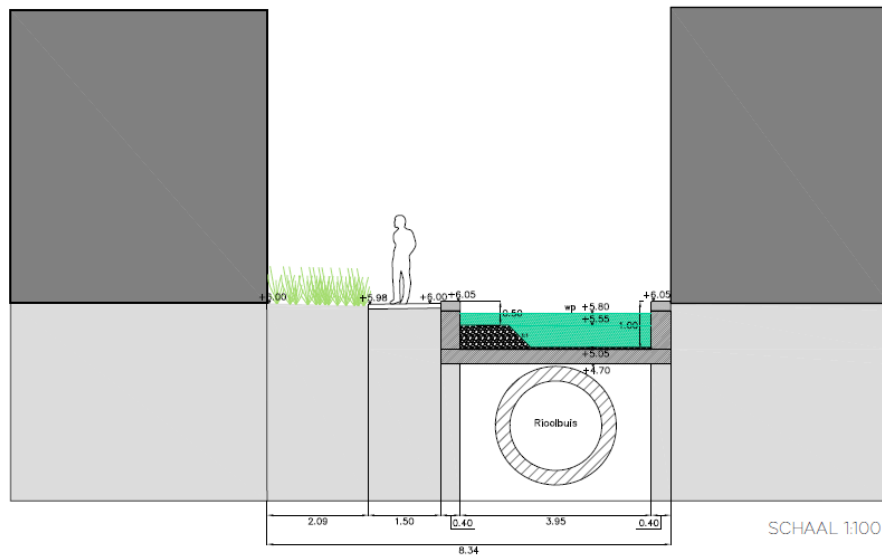

Definitief ontwerp

SNEDE B-B'

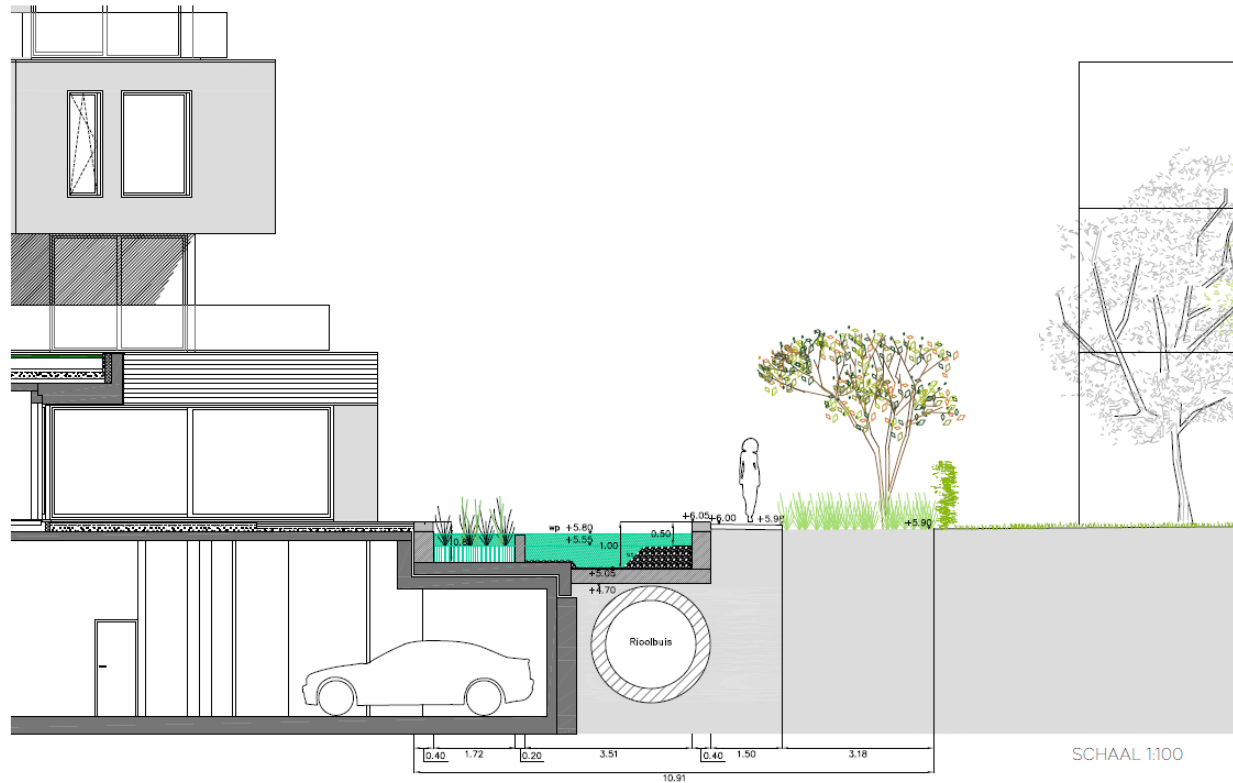

Timing en financieel



Okt 2018 Informatievergadering ontwerp aan bewoners

Eind 2018 – begin 2019

Opmaak definitief ontwerp

Uitvoeringsdossier

Bouwaanvraag

Oktober 2019

Start Werken -> voorziene duur werken
(100 kalenderdagen)

Raming werken

1,21 miljoen euro (incl. BTW)

Subsidies projecten WRC = 60% op 500.000 euro investeringen