



VLIET

MUNTSTRAAT - ZAKSTRAAT

MECHELEN

VO CONCEPT

OKRA

WRC PROJECT

Interreg 
EUROPEAN UNION
2 Seas Mers Zeeën
Water Resilient Cities
European Regional Development Fund

BINNENSTADSLANSCHAP



HISTORIE VAN DE PLEK



PUBLIEKE TUIN





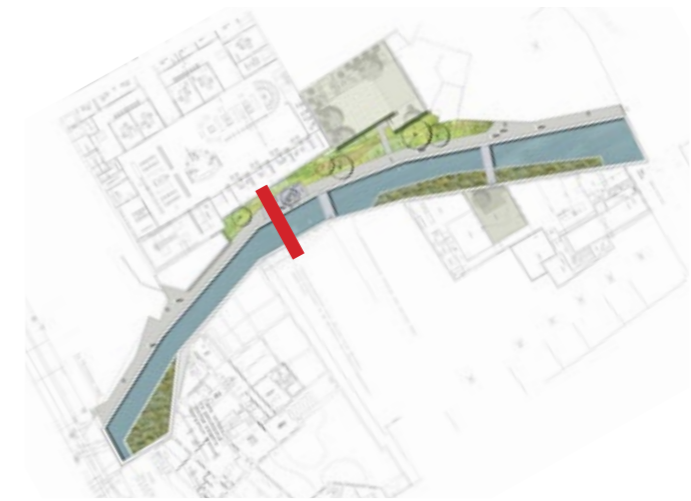
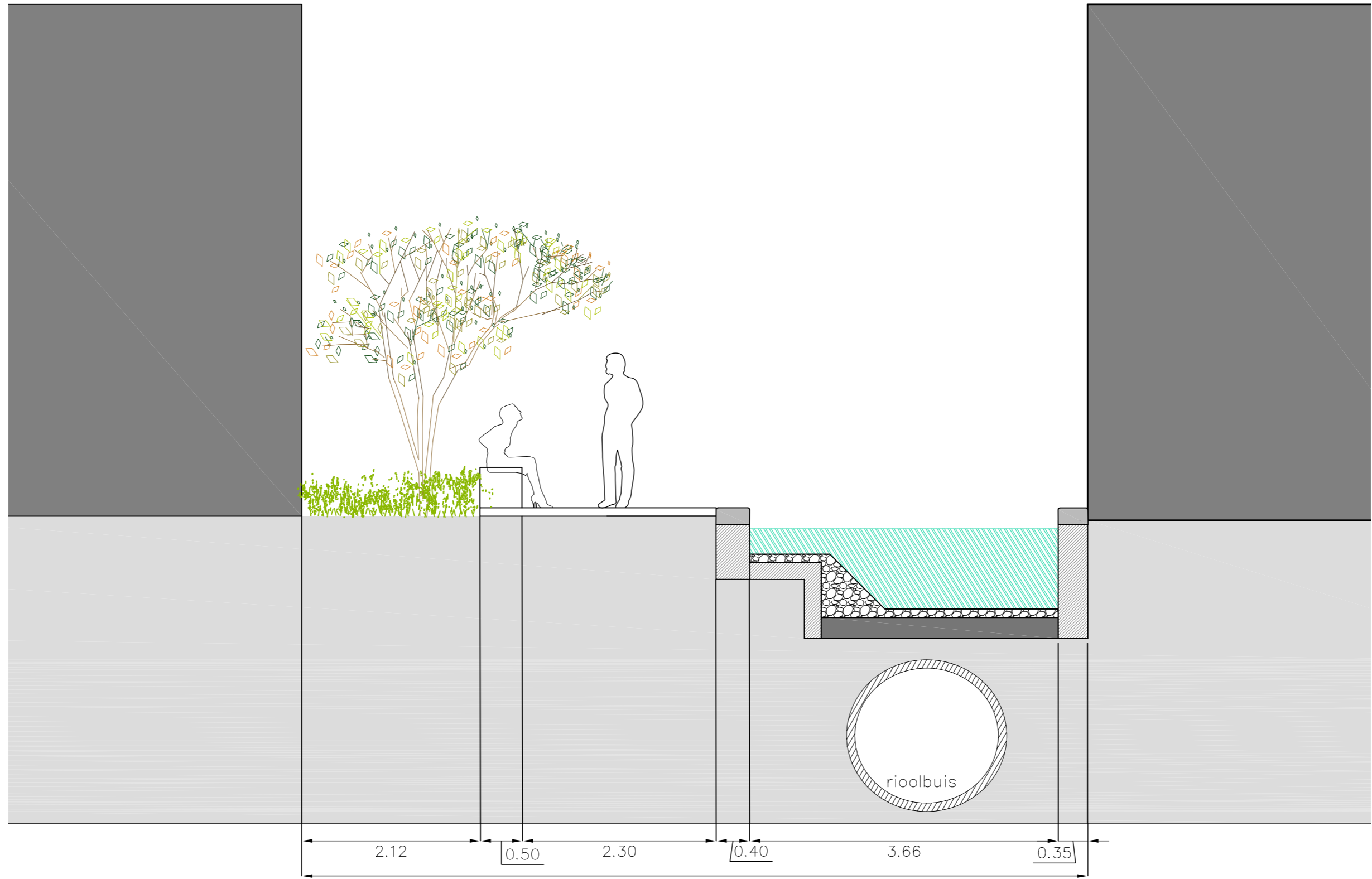

TOEGANGEN, ROUTE

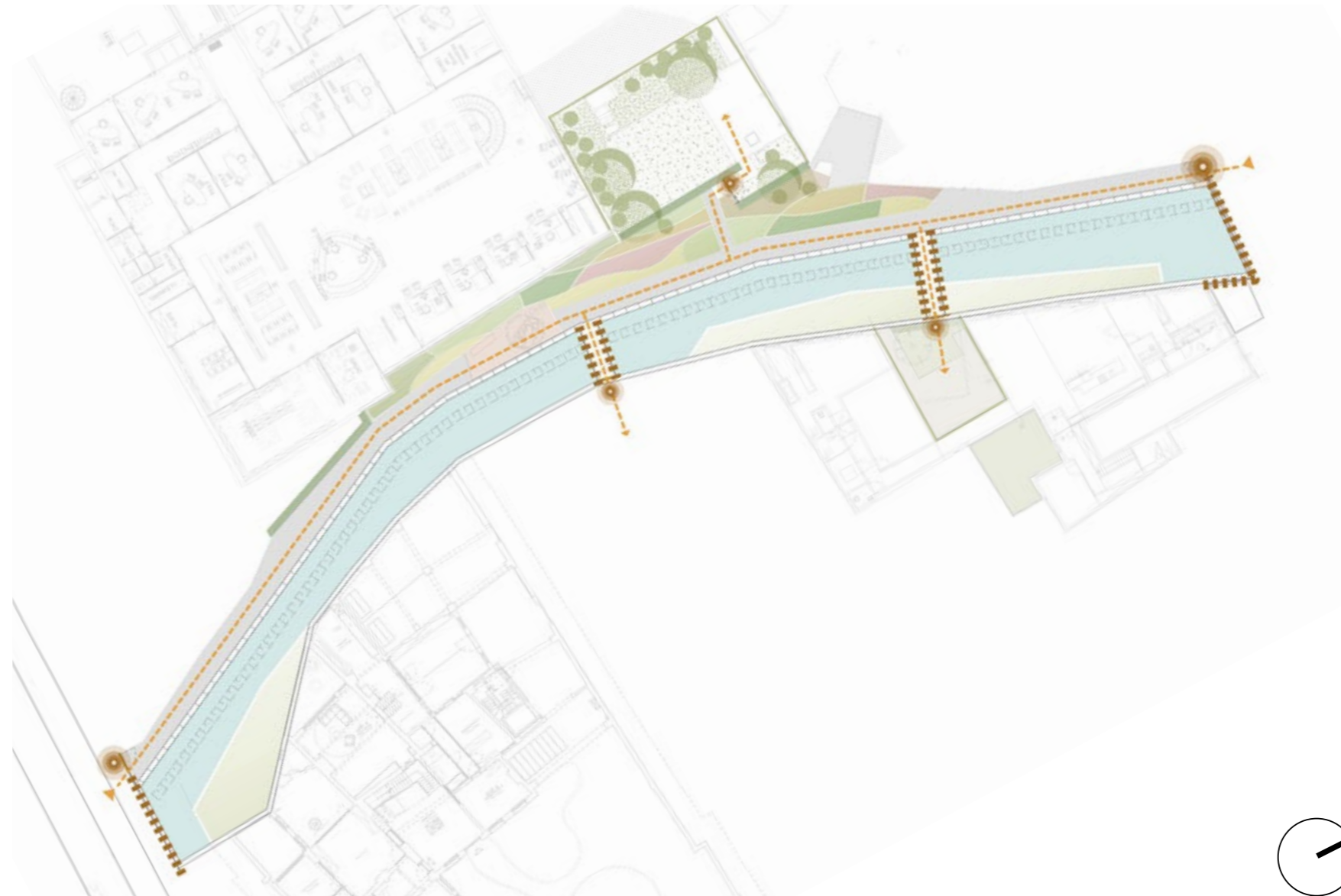

lage reling naar analogie bruggen Melaan



poort: type n.t.b.

TOEGANGEN

BRUGJES EN POORTEN

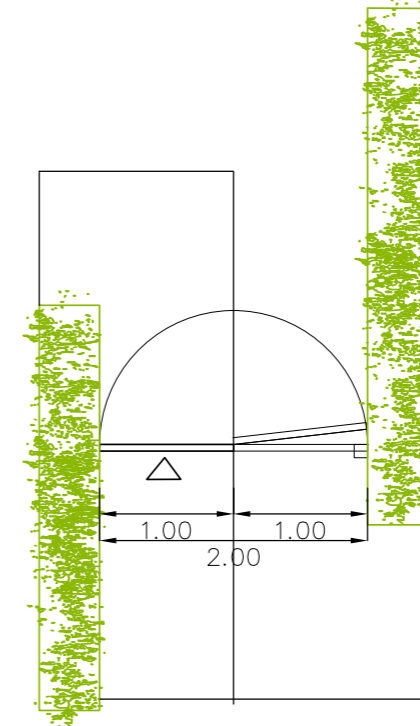
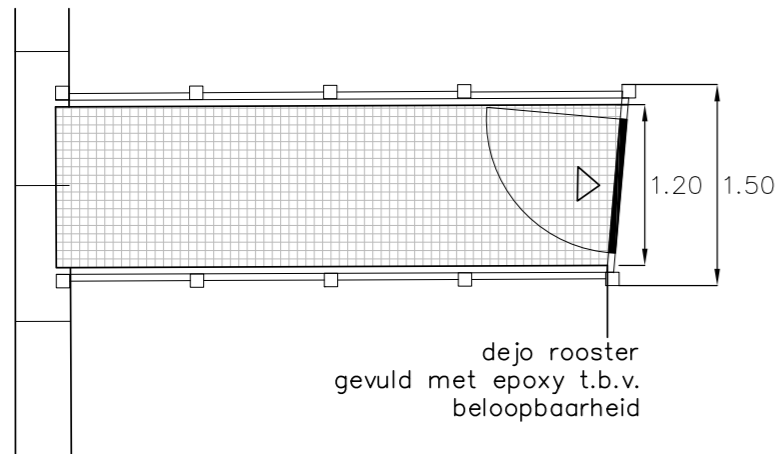
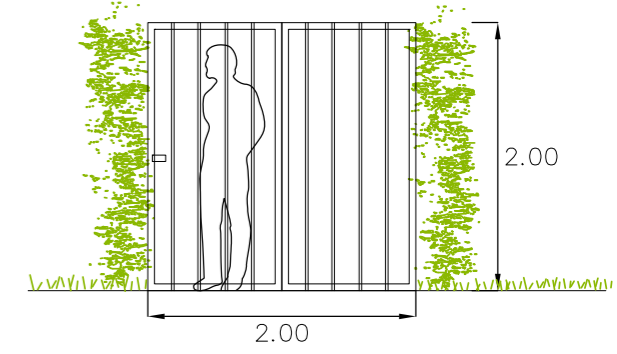
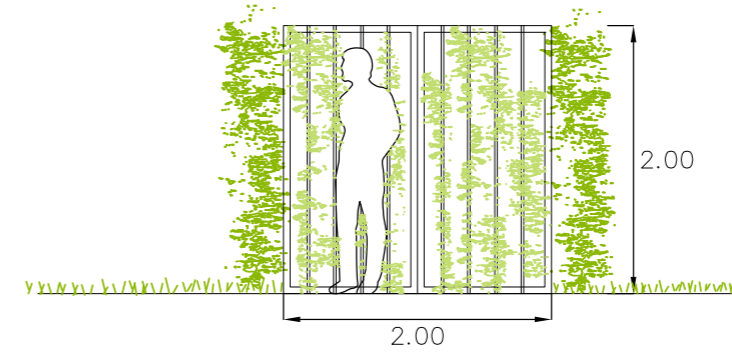
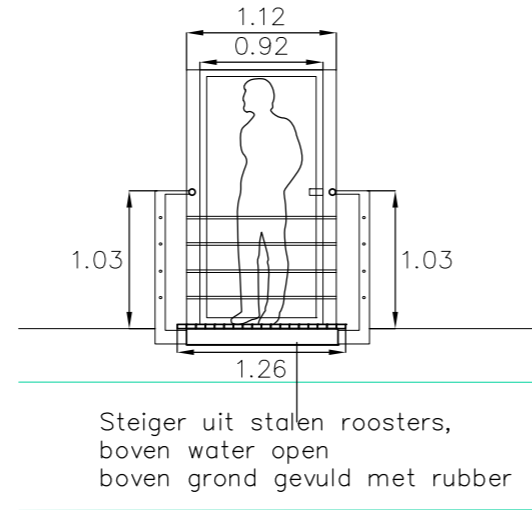
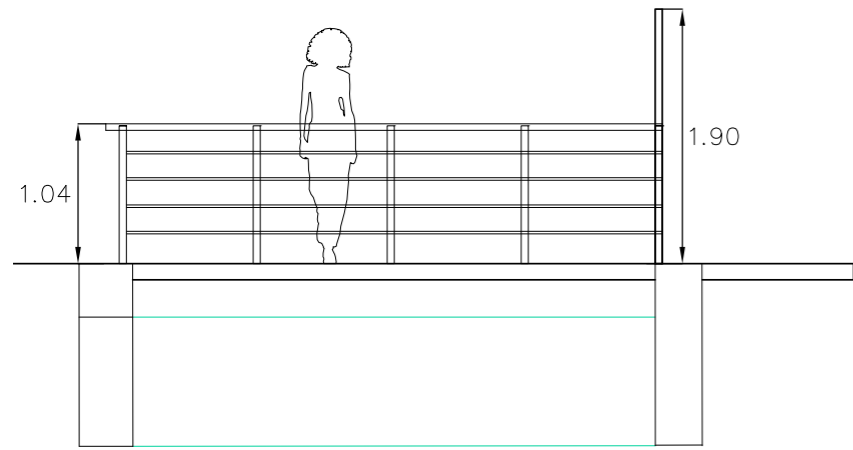

BEPLANTING



allium cristophii

Panicum virgatum 'Heavy Metal'

Knautia macedonica

Potentilla fruticosa 'Abbotswood'

laurustinus-viburnum-tinus



Pennisetum villosum *Knautia macedonica*



Aconitum carmichaelii 'wilsonii'

Pennisetum villosum



BOMEN



-  *Prunus subhirtella* 'Autumnalis Rosea' H: tot 5 m. vorm: meerstammig
-  *Cornus kousa* H tot 6-7 m
-  *Syringa vulgaris* 'Sensation' H: tot 4 m . vorm: meerstammig

HELOFYTENFILTER



Helofytenfilter 1:

Iris pseudacorus
Acorus calamus
Phragmites australis
Sparganium erectum
Scirpus lacustris
Alisma plantago aquatica
Carex pseudocyperus
Ranunculus lingua 'Grandiflora'

Helofytenfilter 2:

Acorus calamus
Butomus umbellatus
Lytrum salicaria 'Robert'
Pontederia cordata
Lysimachia thyrsoiflora
Caltha palustris

MATERIALIZATIE

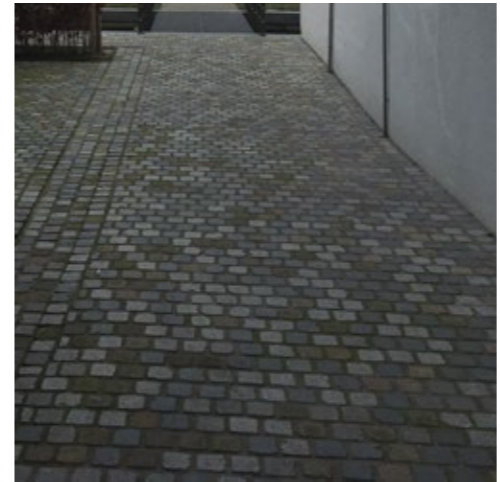
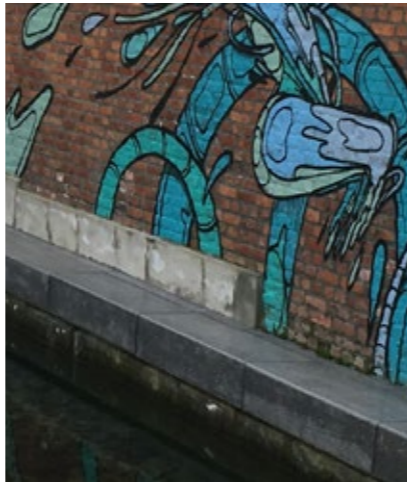
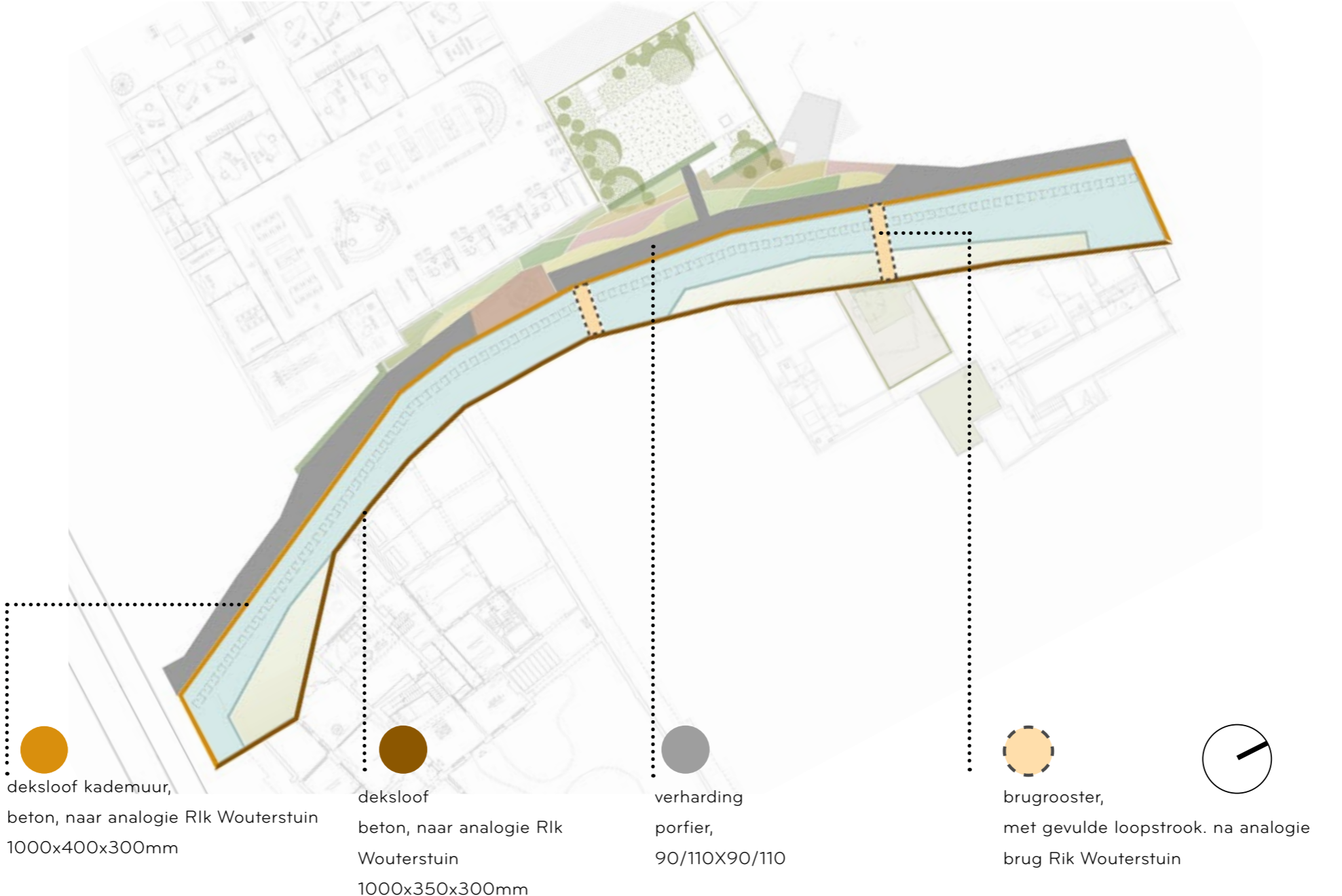

VERLICHTING



wandspot, strijklucht over op vliet



wandarmatuur

